

10 m

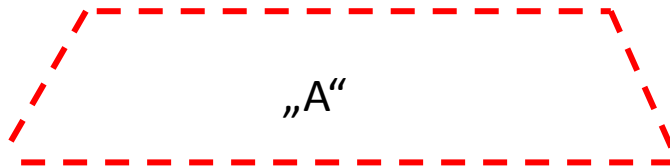

Stage Nr	01
Range	04
Type of course	Short
Consisting of	2 targets, 6 popper, 2 plates, 1 ns-popper
Min. rounds /max. points	12 / 60
Starting position	Standing anywhere inside „A“, empty gun in the holster.
Procedure	
Special remarks	

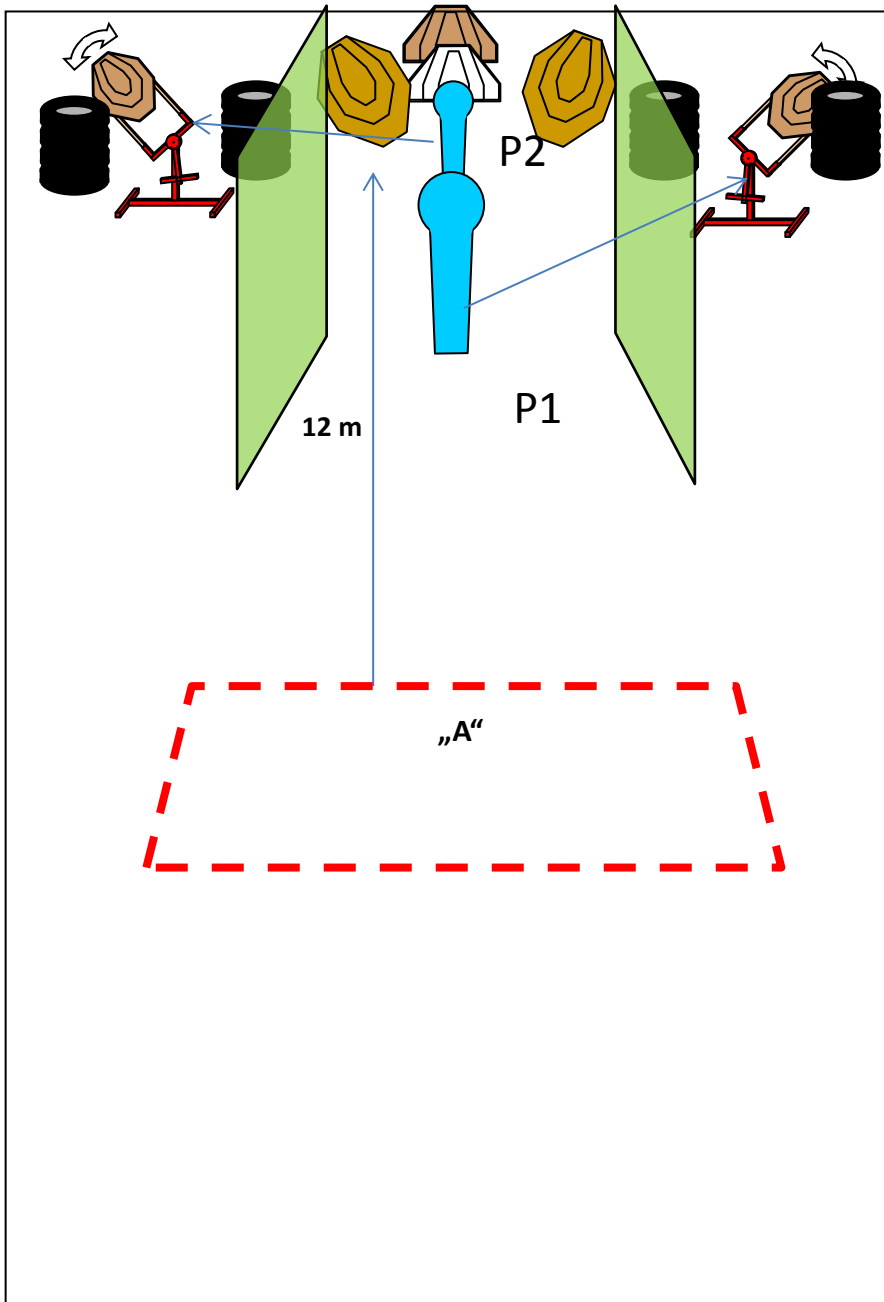

Stage Nr	02
Range	04
Type of course	Short
Consisting of	5 targets, 2 popper, 1 ns
Min. rounds /max. points	12 / 60
Starting position	Standing at „A“, gun in ready condition holstered.
Procedure	
Special remarks	

BRUNOX[®]
LUB & COR[®]

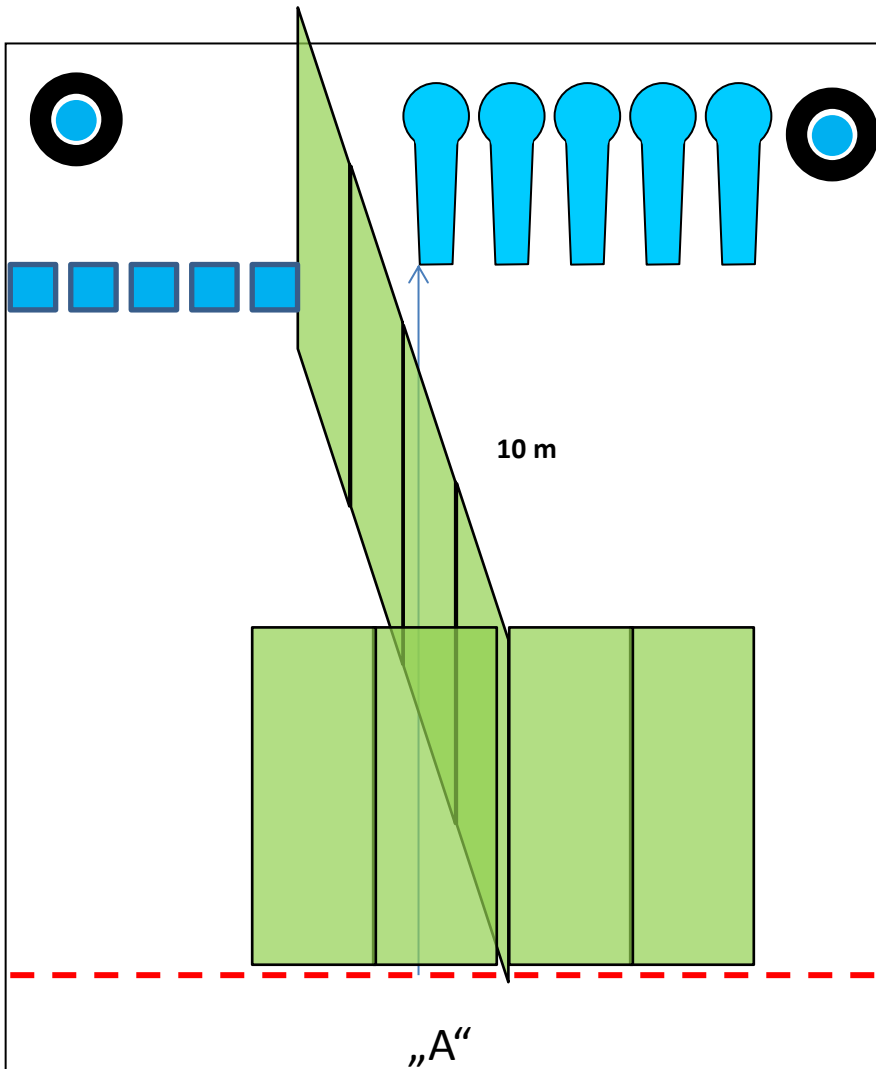

Stage Nr	03
Range	05
Type of course	Short
Consisting of	5 poppers, 7 plates
Min. rounds /max. points	12 / 60
Starting position	Standing anywhere at „A“, gun in ready condition holstered.
Procedure	
Special remarks	



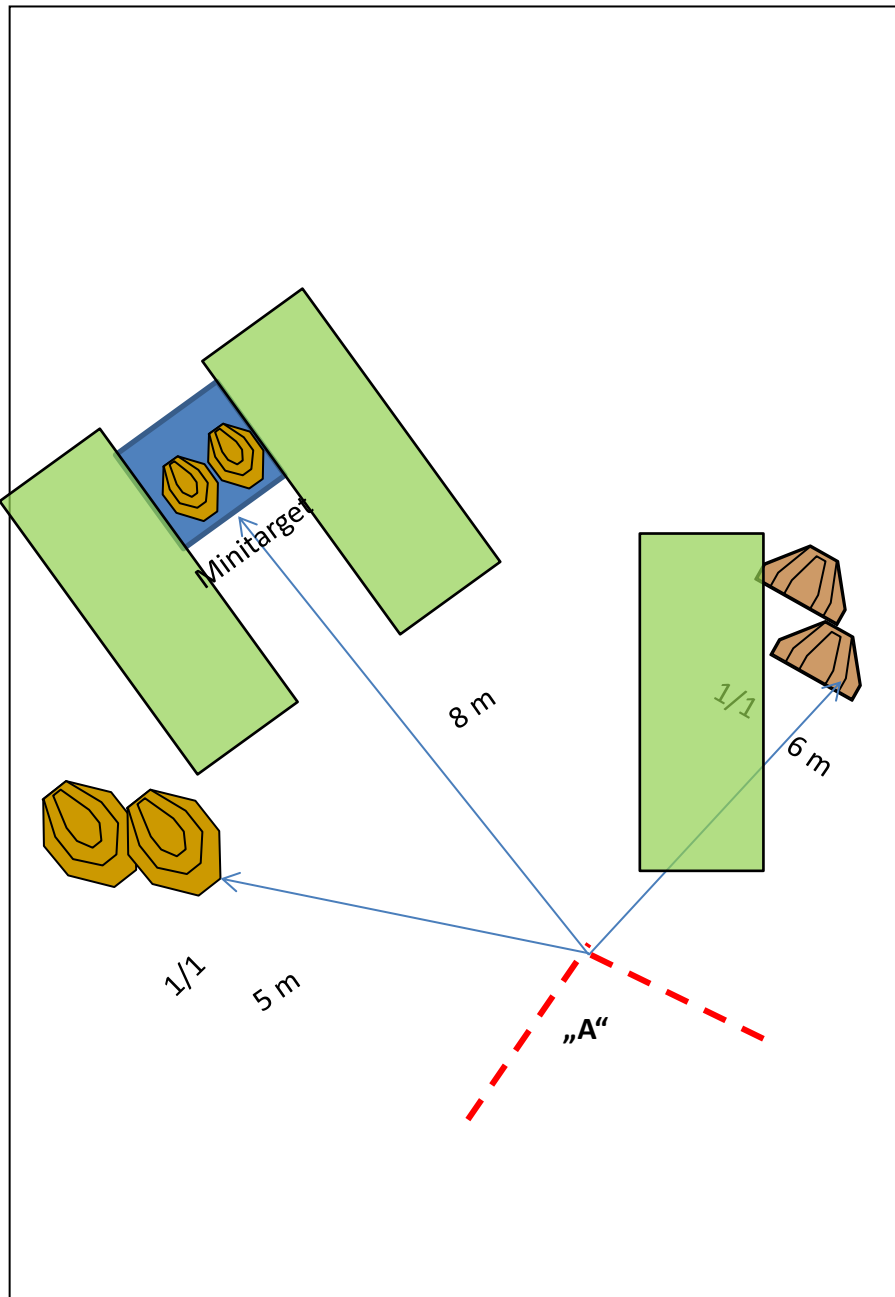

Stage Nr	04
Range	05
Type of course	Short
Consisting of	4 IPSC targets, 2 Minitargets
Min. rounds /max. points	12 / 60
Starting position	Standing at „A“, gun in ready condition holstered.
Procedure	
Special remarks	



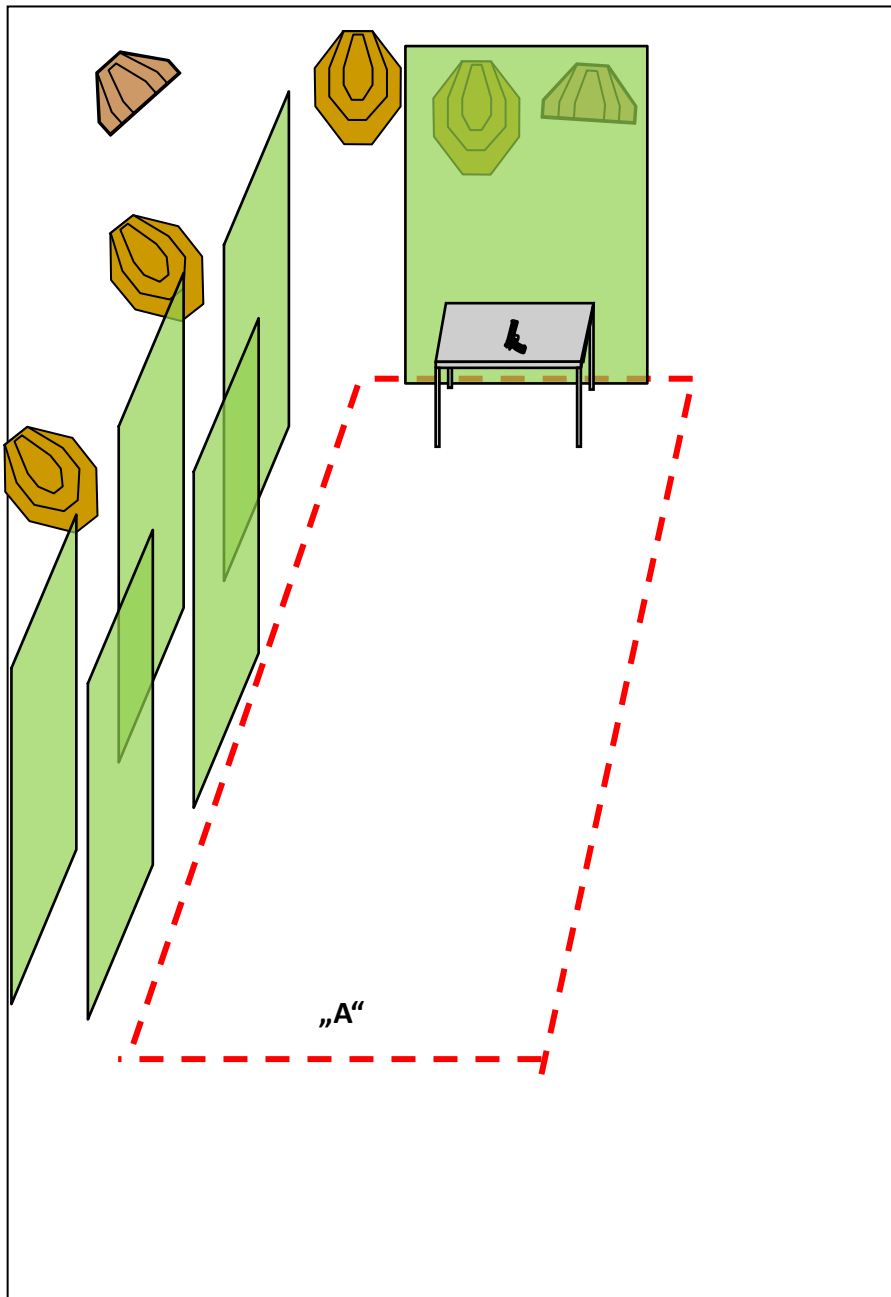

Stage Nr	05
Range	06
Type of course	Short
Consisting of	6 IPSC targets
Min. rounds /max. points	12 / 60
Starting position	Standing at „A“, gun in ready condition on the table, all magazines on the table too.
Procedure	
Special remarks	

MINOX
 VISIBLE INNOVATION

Fernoptikcenter Rhein-Main
 Inh. Michael Wolf
 Eisenbahnstr. 25
 63303 Dreieich
 Tel: 06103-2024751
 www.fernoptikcenter-
 rheinmain.de

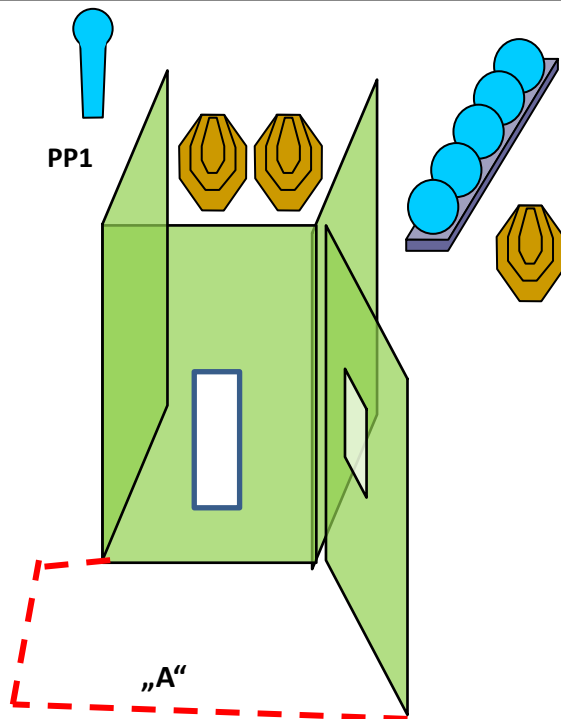

Stage Nr	06
Range	06
Type of course	Short
Consisting of	3 IPSC targets, 1 popper, 5 plates
Min. rounds /max. points	12 / 60
Starting position	Standing at „A“, gun in ready condition holstered
Procedure	
Special remarks	

Prommersberger
Büchsenmacherei
STI-Importeur Deutschland

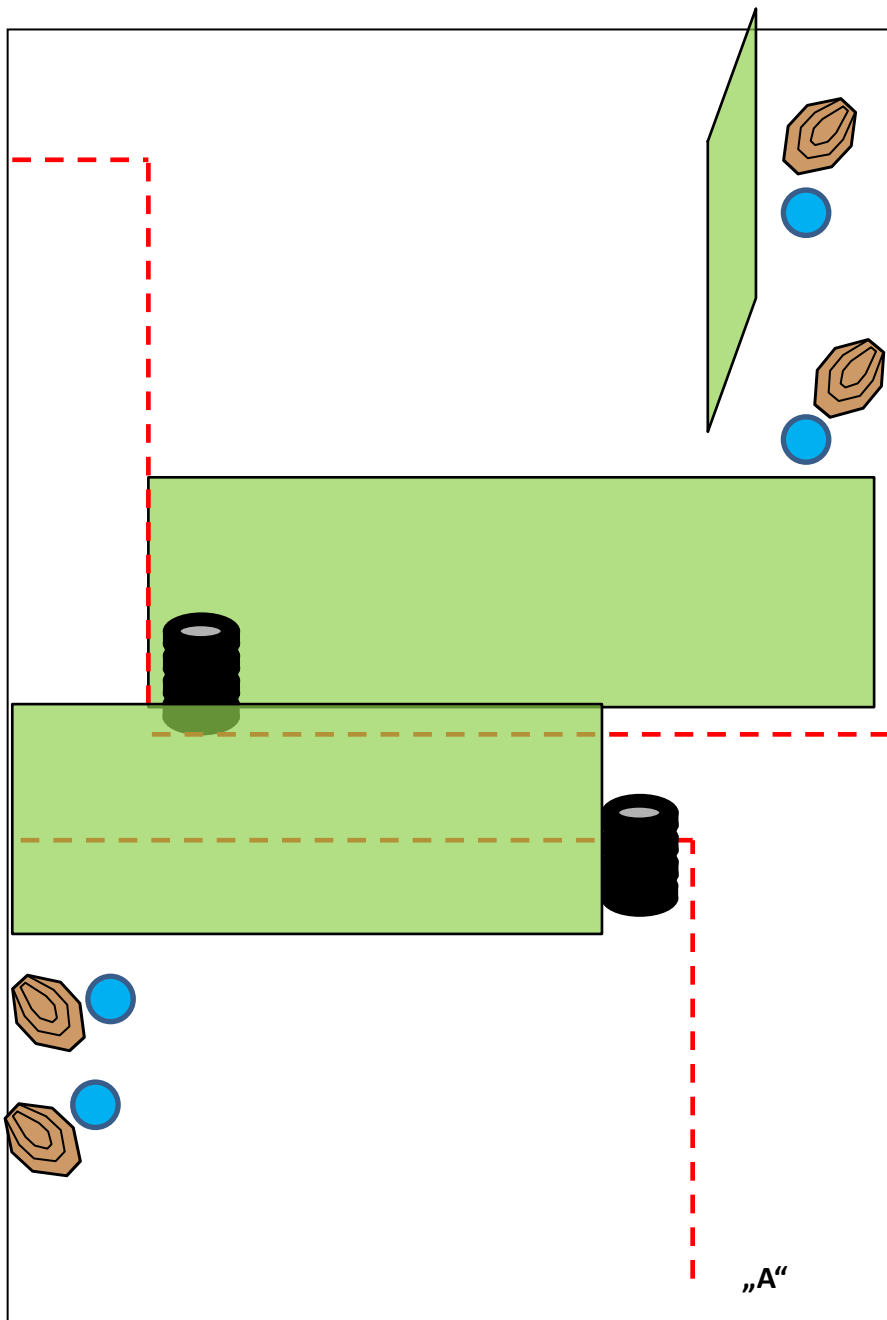

Stage Nr	07
Range	07
Type of course	Short
Consisting of	4 IPSC targets, 4 plates
Min. rounds /max. points	12 / 60
Starting position	Standing at „A“, gun in ready condition holstered
Procedure	
Special remarks	



ČESKÁ ZBROJOVKA
SINCE 1936

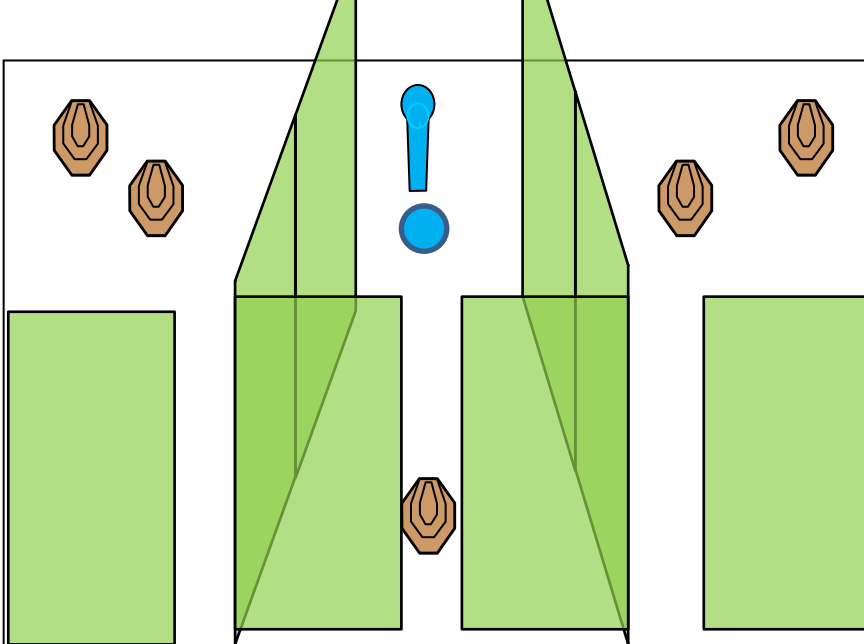

„A“

„B“

Stage Nr	08
Range	07
Type of course	Short
Consisting of	5 IPSC targets, 1 popper, 1 plate
Min. rounds /max. points	12 / 60
Starting position	Standing at „A“, gun loaded and holstered, but chamber empty. Shooter facing uprange.
Procedure	
Special remarks	



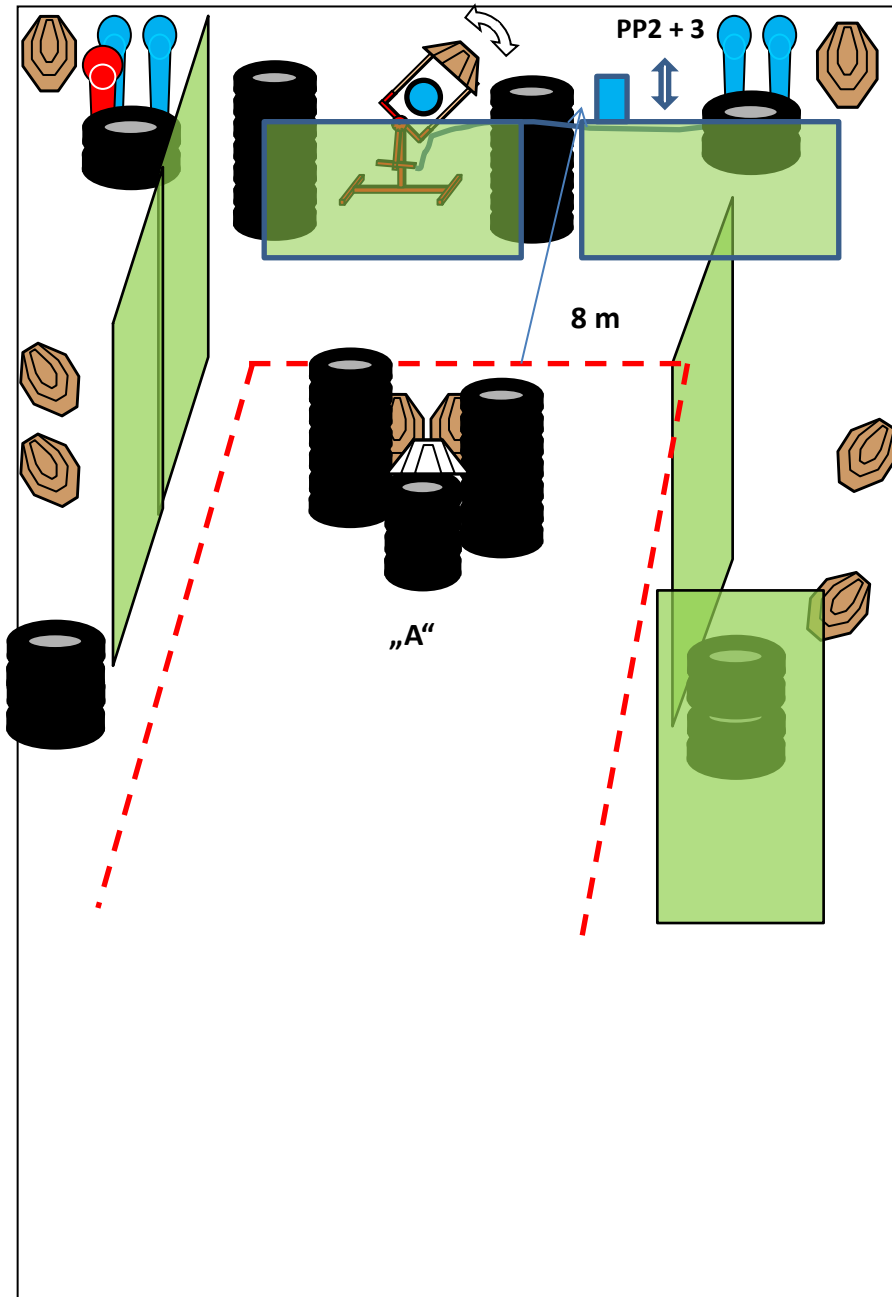

Stage Nr	09
Range	08
Type of course	Medium
Consisting of	9 IPSC minitargets, 4 popper 2 plates, 1 no shoot, 1 no shoot popper
Min. rounds /max. points	24 / 120
Starting position	Standing at „A“, empty gun holstered
Procedure	PP2 activates swinging plate/target, PP3 activates up/down plate. Both moving targets covered by steel wal.
Special remarks	All targets are Minitargets. Paper Targets remain visible in final position.

SIG SAUER
when it counts™

SIG516 PATROL
.223 Rem.
ONS16850

SIG SAUER GmbH & Co. KG · D-24340 Eckernförde · Sauerstraße 2 · 6 · fon +49 (0) 4351 471 0 · fax +49 (0) 4351 471 160 · www.sigsauer.de

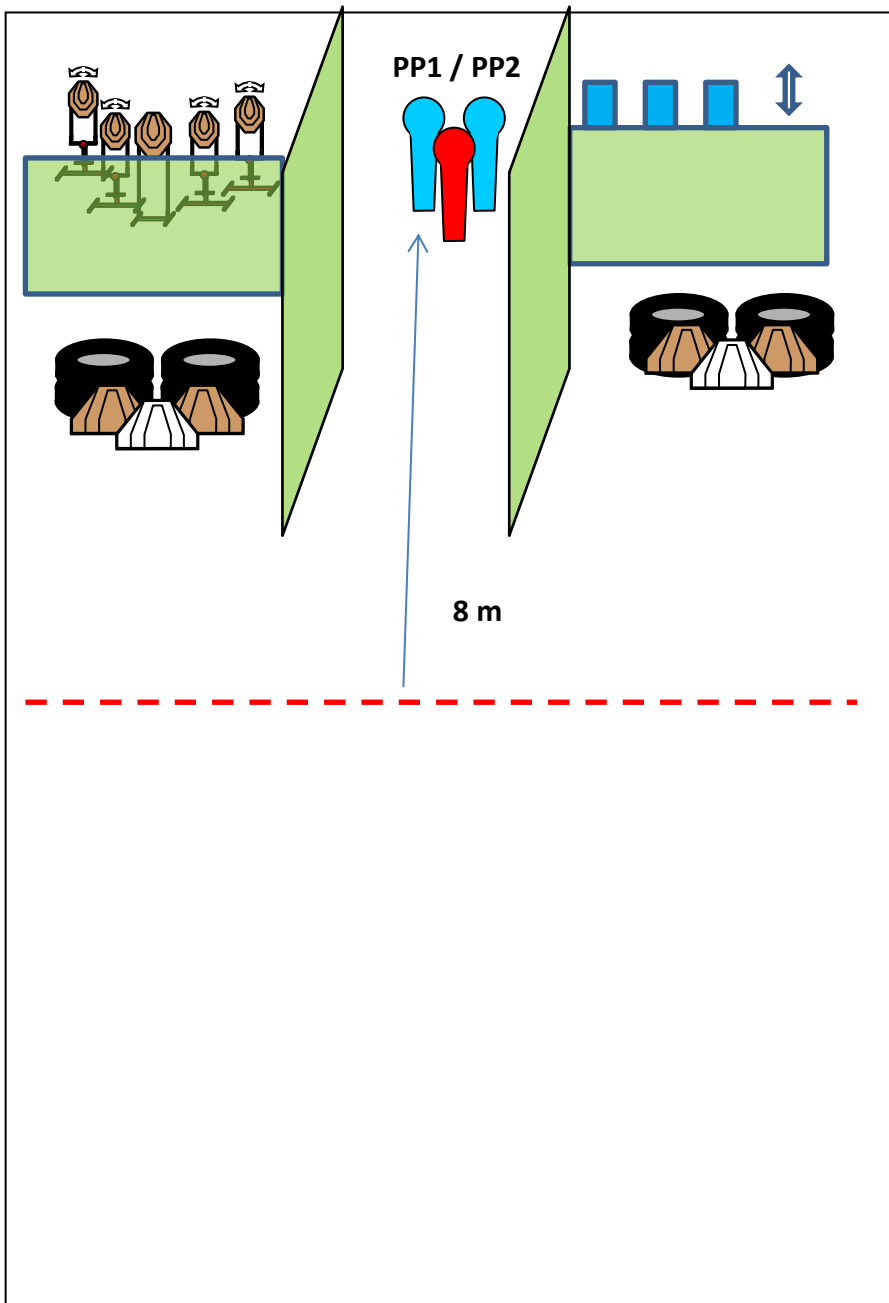

Stage Nr	10
Range	09
Type of course	Medium
Consisting of	4 IPSC Targets, 1 Minitarget, 4 Disapearing Targets, 2 popper 3 plates, 2 no shoot, 1 no shoot popper
Min. rounds /max. points	23 / 115
Starting position	Standing at „A“, gun in ready condition holstered
Procedure	PP1 activates 4 gravity turners, activated 1 by another in a row. PP2 activates 3 up/down plates, also activated 1 after the other Both mooving targets covered by steel wal. Plates remain visible in final position.
Special remarks	



FUN SHOOTING
ACTION - TARGETS
 by Oliver Winkler

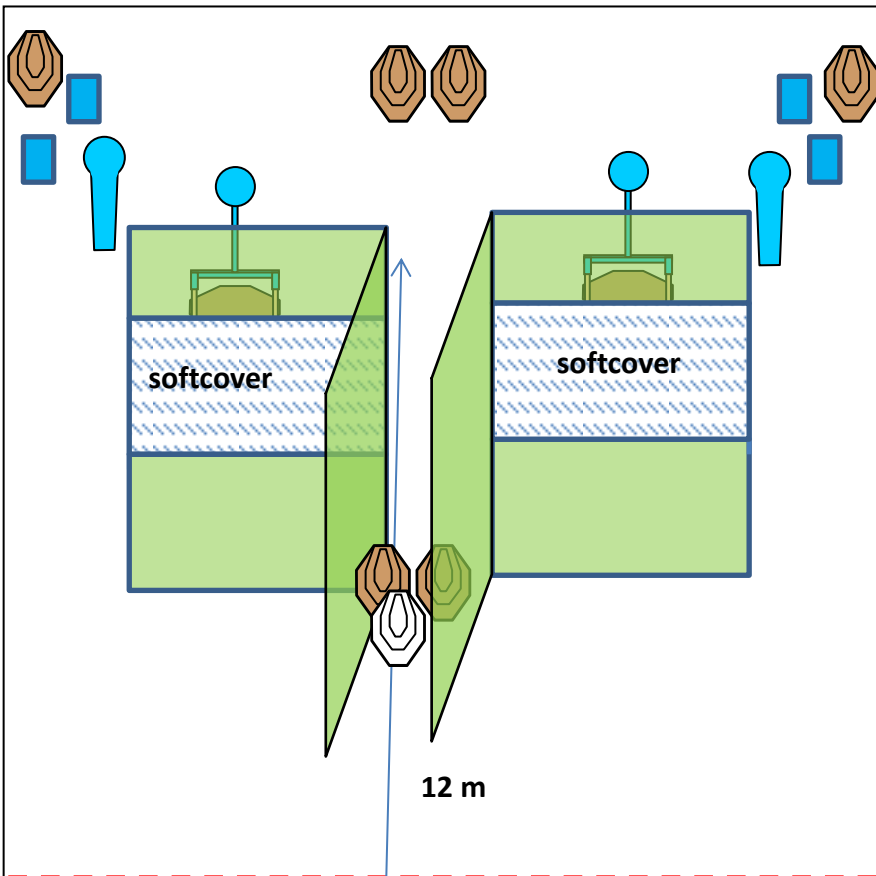

Stage Nr	11
Range	10 A
Type of course	medium
Consisting of	8 IPSC Targets, 2 popper 6 plates, 1 no shoot,
Min. rounds /max. points	24 / 120
Starting position	Standing anywhere on the firing line, gun in ready condition holstered
Procedure	2 fliptargets are activated by plates and remain visible in final position
Special remarks	



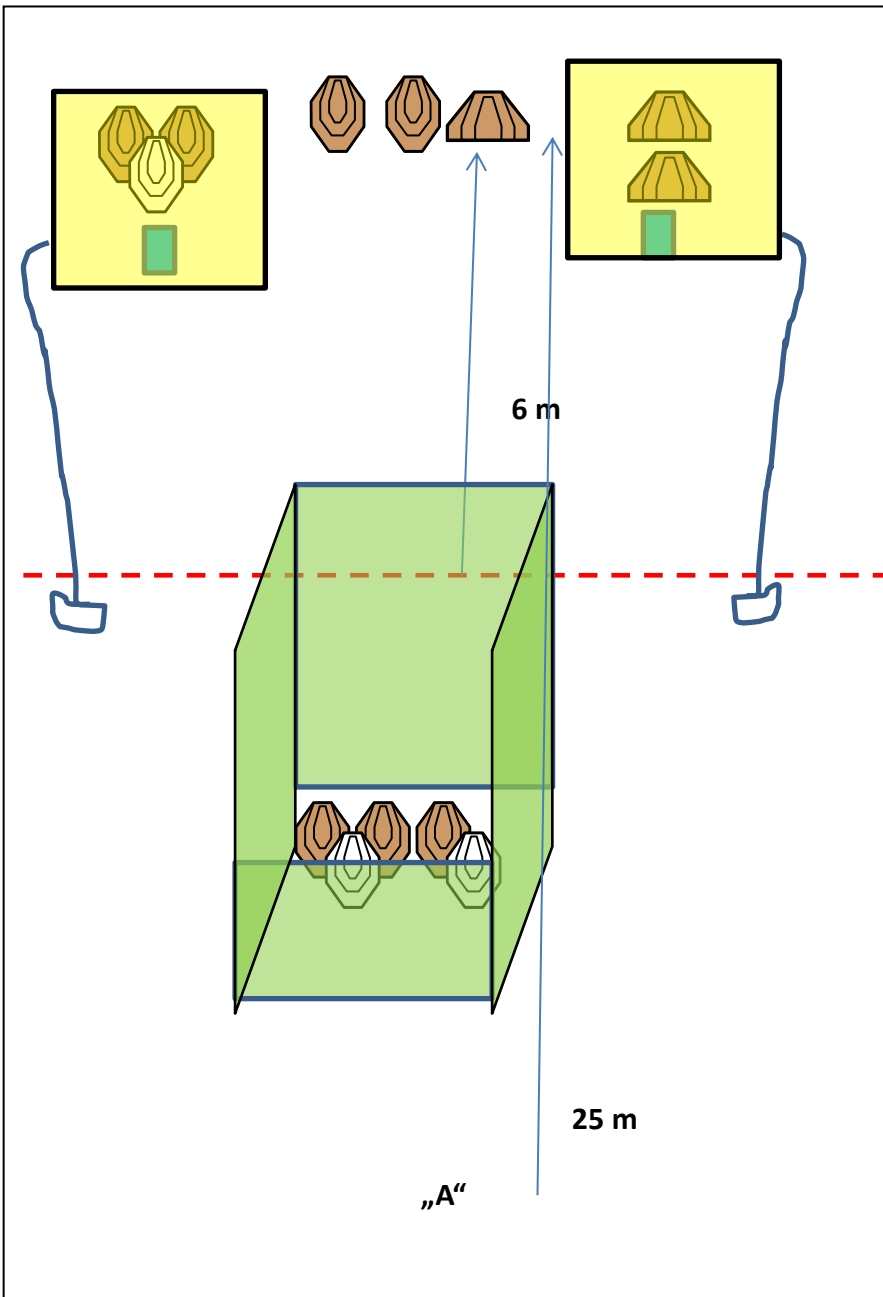

Stage Nr	12
Range	10 B
Type of course	medium
Consisting of	10 IPSC Targets, 2 Plates, 3 no shoot,
Min. rounds /max. points	22 / 110
Starting position	Standing at „A“, gun in ready condition holstered
Procedure	Pulling each of the ropes will open the corresponding window/door to shoot the targets
Special remarks	

LASERGRAVUREN
www.RENGART.de
info@rengart.de • Mobil 0172 960 4891
Vereinsbedarf
Stempel - Schilder - Pokale - Textilveredelung
LED LENSER® trodat® TROIKA® VARTA
OPTOELECTRONICS GERMANY

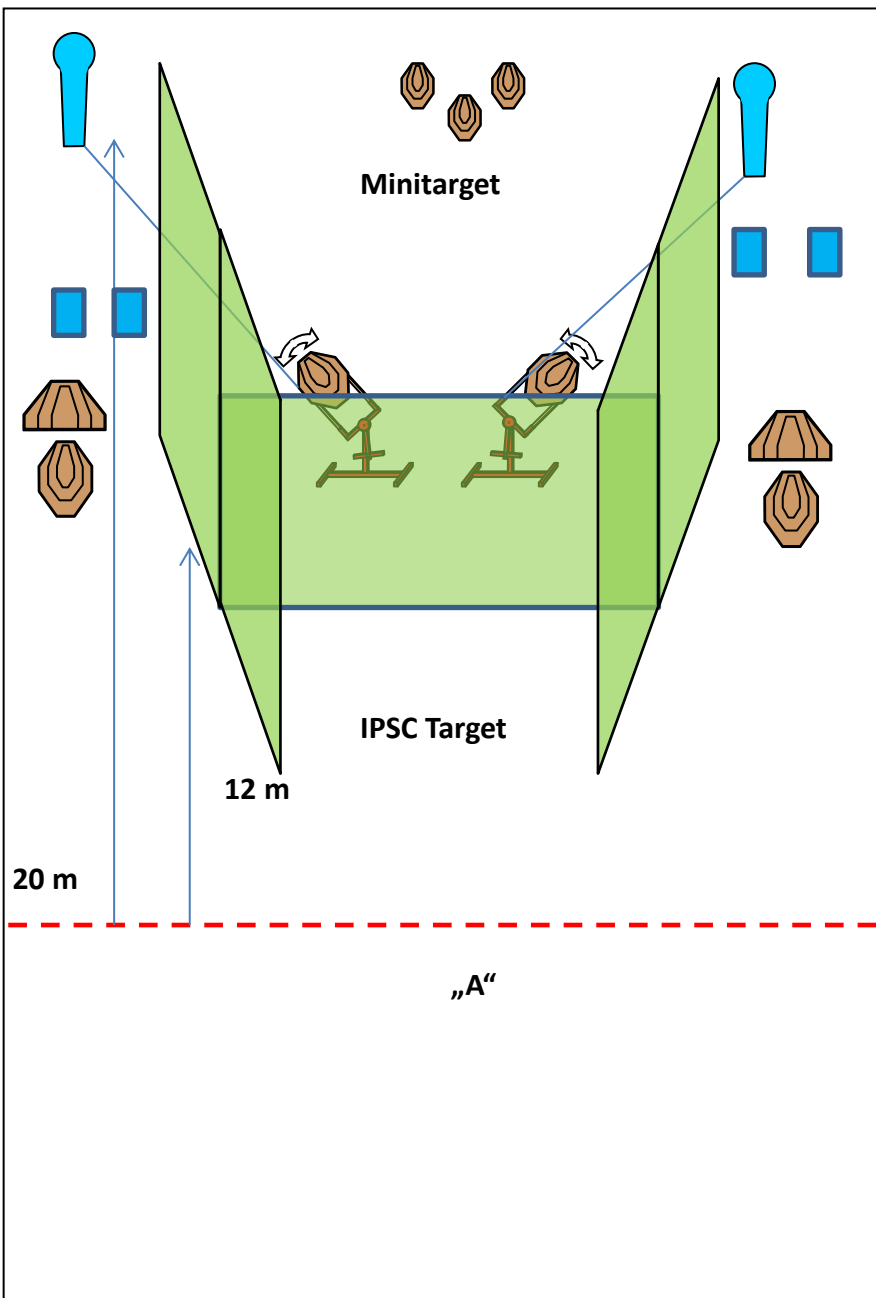

Stage Nr	13
Range	11
Type of course	medium
Consisting of	6 IPSC Targets, 3 Minitargets, 2 Popper, 4 Plates
Min. rounds /max. points	24 / 120
Starting position	Standing at „A“, gun loaded and holstered, but chamber empty. Facing uprange.
Procedure	Paper Targets remain visible in final position.
Special remarks	

ATLAS-TAKTIK.DE
 Taktische Ausrüstung - Zubehör - Bekleidung

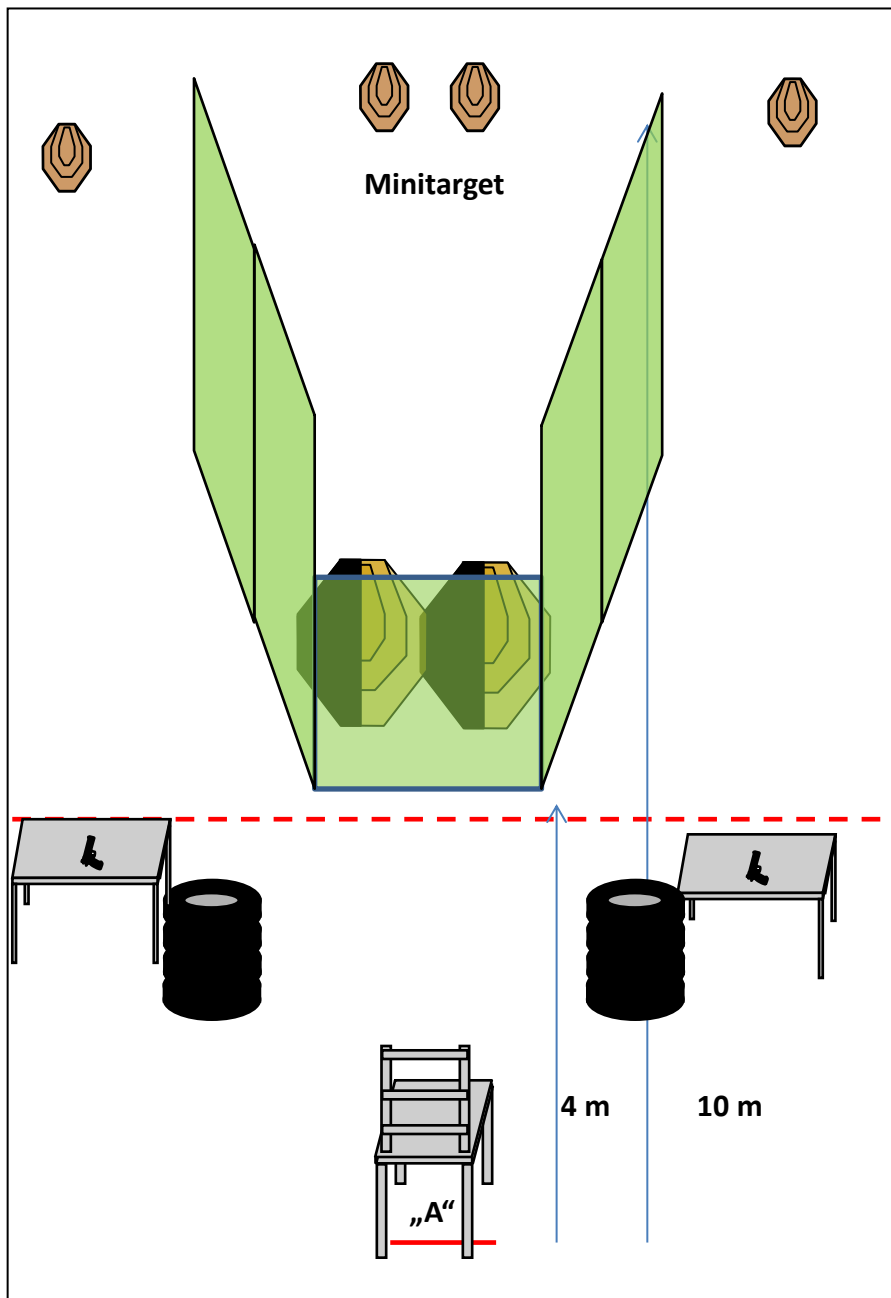

Stage Nr	14
Range	12
Type of course	short
Consisting of	2 IPSC Targets, 4 Minitargets,
Min. rounds /max. points	12 / 60
Starting position	Sitting firmly on the chair, hands touching the knees, gun in ready condition on left or right table.
Procedure	
Special remarks	Build the stage to left side of the range; right side place chrono



Heribert Bettermann
Qualitätswaffen aus Deutschland

www.heribert-bettermann.de

SCHIESSAUSBILDER UND OFFIZIELLER HANDELSPARTNER:

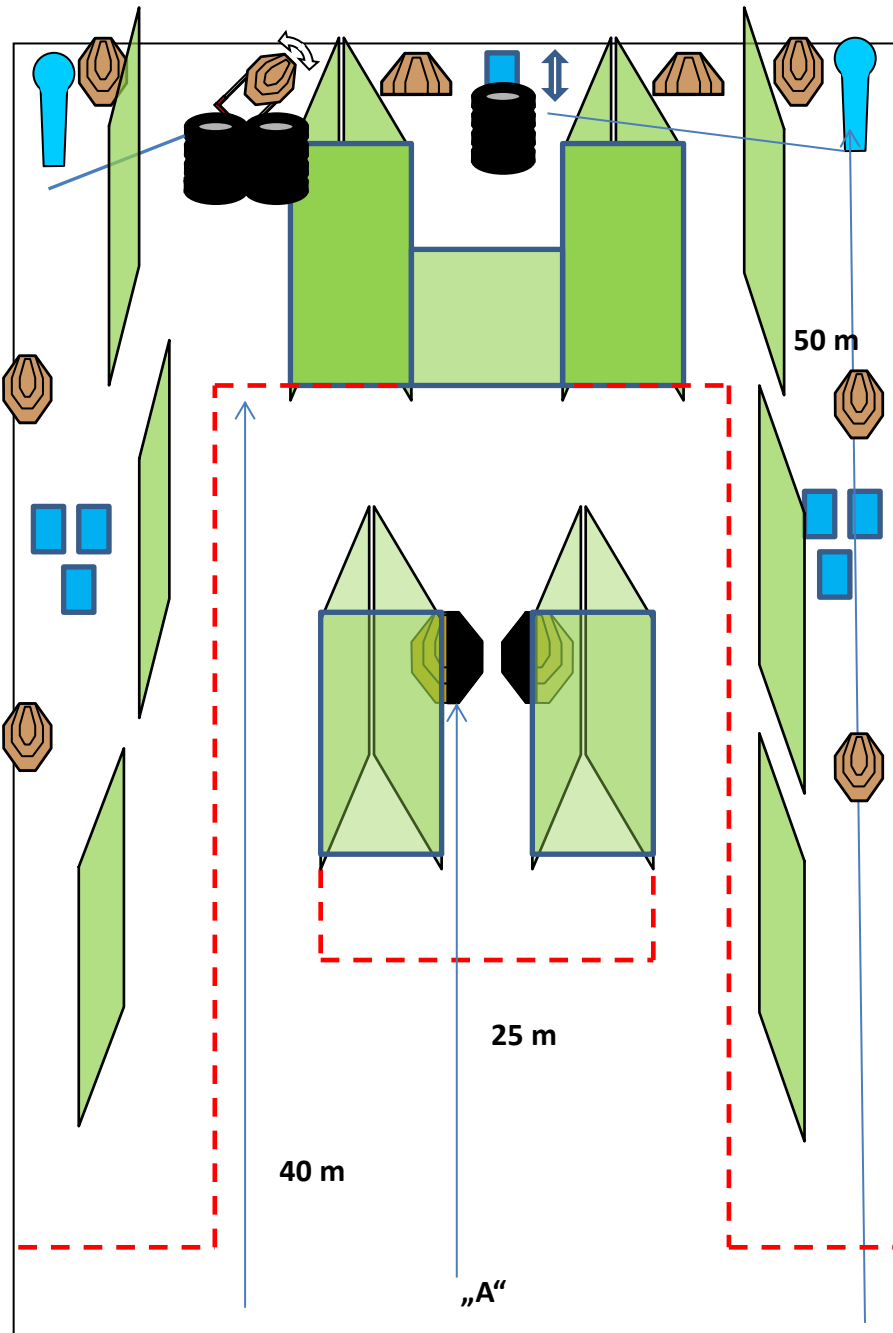

Stage Nr	15
Range	13
Type of course	long
Consisting of	11 IPSC Targets, 2 Popper, 7 Plates
Min. rounds /max. points	31 / 155
Starting position	Standing at „A“, gun in ready condition holstered
Procedure	Left popper activates swinger, right popper activates up-down target. All targets remain visible in final position.
Special remarks	



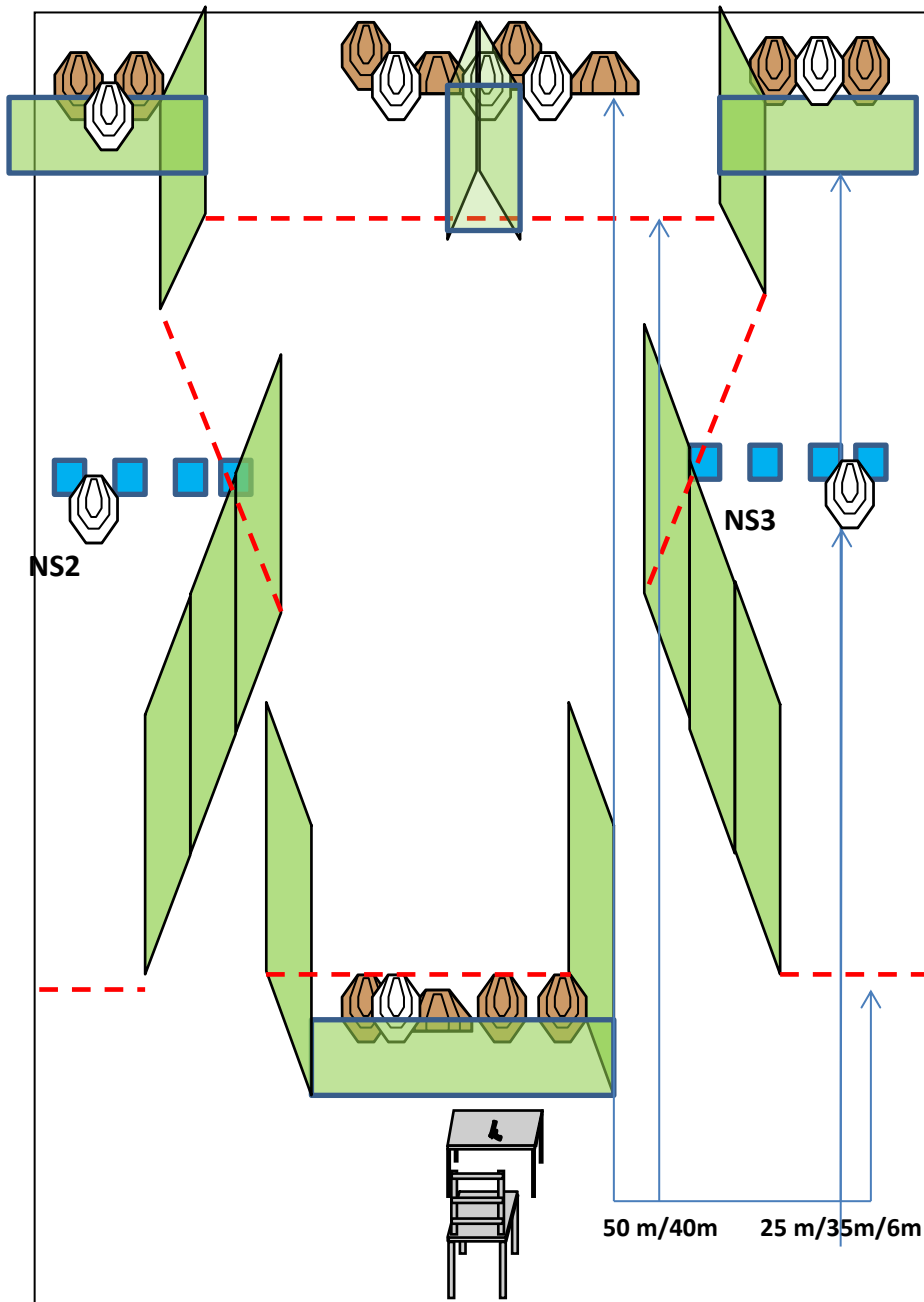

Stage Nr	16
Range	14
Type of course	long
Consisting of	12 IPSC Targets, 8 Plates, 5 No shoot
Min. rounds /max. points	32 / 160
Starting position	Sitting firmly on the chair, gun in ready condition on the table.
Procedure	
Special remarks	For NS2 und NS 3 use steel NS or steel-NS-plates.

